



ISOTTA[®]

HOUSINGS and ACCESSORIES
for UNDERWATER PHOTOGRAPHY

Instructions for Nikon D7500

www.isotecnic.it







Nikon D7500

Housing instructions

Thank you for your purchase of an Isotta Housing for your Camera.

We are confident that you will benefit from the outstanding performance of our product, manufactured using the most advanced technology available.

Isotta designs and crafts underwater camera housings and accessories for DSLR, compact, mirrorless and action cameras (GoPro and ZCam). **100% Made in Italy**, the company has been making high-end underwater camera equipment since 1980 in Castelnovo del Garda (Verona), Northern Italy.

Made in Italy stands for high quality of manufacturing and materials to provide long lasting equipment for the demanding underwater photographer and a thorough reproduction of all camera controls from outside for a comfortable and enhanced performance underwater.

Each product is tested individually to ensure its quality, perfect functionality and highest precision. Each single part of the housing is inspected and reexamined with a manual process in all production phases, until the final test in the hyperbaric chamber with pressure depth to 100 metres. Our commitment to premium quality extends to every level of the production process, from safety to performance.

Please read this manual carefully before using the housing, this will maximise its performance as well as its lifetime. Below you will find all the necessary information for the use of this product.

The illustrations in this manual may differ from the actual product.



Thank you for purchasing a product of the line ISOTTA.

We are confident that you will benefit from the outstanding performance of our product, manufactured using the most advanced technology available.

Our service goes wherever you go:

 **+39 045 6450480**

 **support@isotecnic.it**

You can also view all the products in the line including accessories for the product purchased on the website at:

www.isotecnic.it



TABLE OF CONTENTS

Warranty	pag. 06
Package Contents	pag. 08
Specifications	pag. 09
Precautions	pag. 10
Quick start guide	pag. 11
Parts of the Housing	pag. 12
Opening and Locking the Housing	pag. 14
Installing the Camera	pag. 15
Changing the viewfinder	pag. 15
Mounting the Port	pag. 16
Using the Flash	pag. 17
Troubleshooting	pag. 20
Warnings	pag. 21
Care and Maintenance	pag. 22



WARRANTY

This **Warranty** covers the replacement of parts recognized as defective for manufacturing defects for a period of twenty four (24) months from the date of purchase.

For the purposes of the validity of your warranty you must fill in the **Warranty Certificate** indicating the year, month and date of purchase proven by the corresponding original invoice or purchase receipt issued by the authorized Isotta dealer and the serial number of the product making sure to affix the stamp of the dealer on the certificate.

The **Certificate of Warranty** filled with information must be sent, together with a copy of the invoice/receipt, no later than thirty (30) days from the date of purchase to:

warranty@isotecnic.it

Failure to send the completed, dated and signed **Warranty Certificate** within the 30 days timeframe will disqualify you from claiming under this Warranty.

This **Warranty** becomes void if falsification is made on the invoice or purchase receipt.

*This **Warranty** does not cover the following:*

1. Any defect that occurs due to mishandling or negligence by the purchaser, or due to use outside the specified limits and in any case all the circumstances that can not be attributed to manufacturing defects.
2. Any defect that occurs due to repair, modification, cleaning, etc. performed by anyone other than Isotta or an Isotta authorized service provider.
3. Any defect or damage that occurs due to transport, a fall, shock, etc. after purchase of the product.
4. Any defect or damage that occurs due to fire and natural disasters, environmental pollution and irregular voltage sources.
5. Any defect that occurs due to careless or improper storage and improper maintenance.
6. Any defect that occurs due to exhausted batteries. Batteries are not guaranteed as they are not manufactured by the company Isotecnic, this does not mean that they are not sourced from the best brands on the market.
7. Any defect that occurs due to sand, mud, etc. entering the housing. Also, being a product not sealed by the manufacturer, it is not guaranteed due to possible flooding causes above-mentioned and not due to manufacturing defects.



8. Isotecnic Srl disclaims any liability for any damage that may directly or indirectly be caused to people, pets or not, or things, caused by flooding due to incorrect installation, use and maintenance of the product.

Isotecnic Srl do not reimburse missed services, travel and transportation costs. Any repair of the equipment under Warranty will always be made at the **Isotecnic Srl** plant and the shipping charges will be paid by the customer.

This Warranty is void if the housing is damaged by interventions not carried out by the staff of **Isotecnic Srl**.

To return your product for service, please contact your regional authorized service centre(s). Please note that this warranty only applies when the product is purchased in the territory where the service centre is located.

Any dispute relating to the application and/or interpretation of the above-mentioned Warranty shall be subject to the exclusive jurisdiction of the Court of Verona, Italy.



PACKAGE CONTENTS

- Isotta-D7500 housing
- Spare O-ring Set
- Lubricant
- Instruction manual



ATTENTION

Remove the shoulder strap clips prior to inserting the camera into the housing!

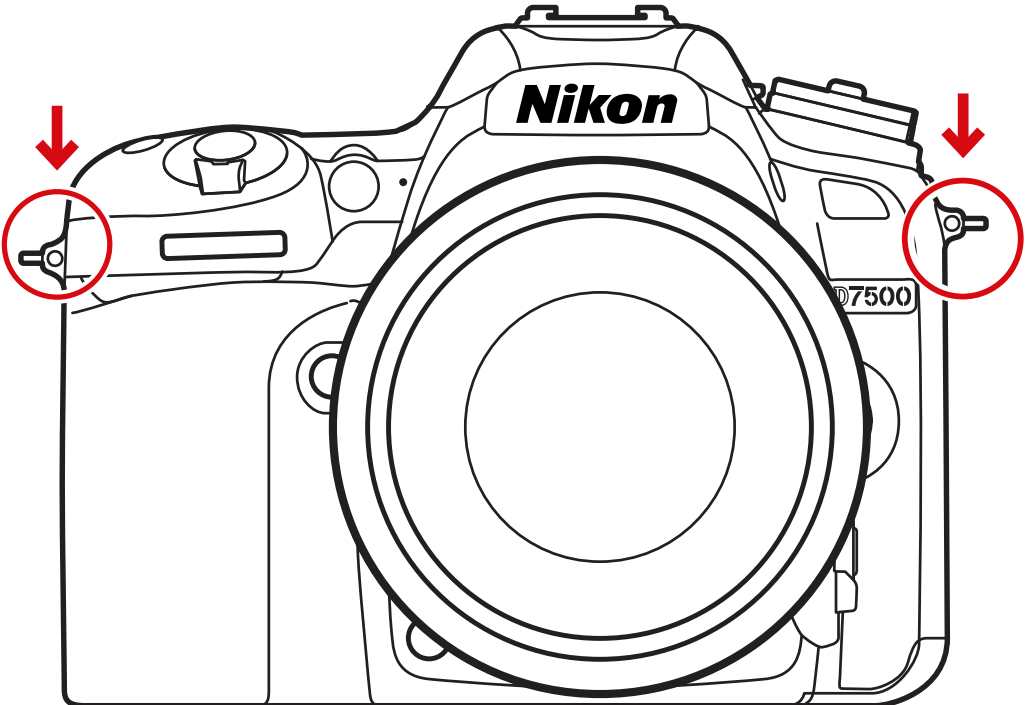



SPECIFICATIONS

All housings are made entirely of **Isotta's** signature red-colored anodized aluminum which is anti-corodal with depth rate to 330ft/100m.

With double O-Ring seals on each button and on all removable parts to make it extra safe against leakages, every housing has clearly labeled camera controls and is closed with Isotta's single handed one-turn knob to be operated with ease.

There are several parts composing the housing.

Understanding how to use them is key to a correct performance underwater.

Body: hard anodized aluminum

Display window: abrasion resistant polycarbonate

Grip handles: hard anodized aluminum

DIMENSIONS

- > **Width:** 190 mm
- > **Height:** 190 mm
- > **Depth:** 130 mm
- > **Weight:** 2.600 grams (handles included)
- > **Buoyancy:** slightly negative
- > **Depth:** rated to 100 metres
- > **Port mount:** -B120 mm
- > **Compatible Camera:** Nikon D7500 Camera
- > **Compatible viewfinders:** INON X-2 compatible;
external viewfinders can be mounted **ON REQUEST.**

FEATURES

- > **Moisture Alarm:** acoustic warning signal and visible red LED signal light, with battery easily replaceable by the user.
- > **Safety Measure:** double O-ring on each movable and removable part.

FLASH CAPABILITY

- > Two fiber optic connectors;
- > Two Nikonos electric bulkheads.



PRECAUTIONS

1. A water-tight test without the camera inside the housing is highly recommended when using the system for the first time and after the changing of port and O-Ring(s).
2. O-rings should be kept clean and lubricated at all times. Discontinue use immediately should you notice any leakage. Do not use lubricants from other brands with the silicone rubber O-ring on this housing, only use the lubricant provided by **ISOTTA**. After checking the O-ring to make sure that there are no scratches, dust, or debris, apply a light coating of silicone grease to the entire O-ring with your finger. Applying too much grease will make it easier for dust and debris to adhere to the O-ring, and could cause flooding.
3. When fitting the O-ring into the O-ring groove, insert it straight into the groove; do not bend or twist it.
4. Store the housing in a robust, shock-proof container during transportation; avoid transporting with any equipment, such as a camera, inside the housing, to avoid breakages.
5. When travelling by air, please remove the port from the housing as this may lead to damages.
6. Do not open the housing in a sandy environment. Protect the interior from moisture and debris in order to prevent malfunction or leakage.
7. Do not store the housing in an environment of high humidity.
8. Do not leave the housing and the camera in direct sunlight for prolonged periods.
9. Do not store the housing in high temperature environment as in the car cockpit under the sun.
10. Keep out of reach of children, failure to do so could result in injury.
11. Always dry the front port, the lens, the flash window or the finder using a soft cloth to prevent stain or salt residue from marring the glass surface. Do not use solvent or alcohol to clean the port, viewfinder or LCD window.
12. When not in use the case for long time O-rings should be removed and stored separately. Replace the O-rings once a year for a secure watertight. Use only Isotta O-rings.
13. Rinse the product with fresh water, after underwater use. Ensure that the product is waterproofed before rinsing. After each dive it is recommended to remove the port from the housing in order to avoid the possibility that the port gets stuck. Storage of the housing is possible only after cleaning and drying its surface.
14. Unauthorized disassembling and/or modification could result in malfunction or flooding, and void product warranty. Take the product to a ISOTTA authorized reseller for repair or inspection. the housing is possible only after cleaning and drying its surface.



QUICK START GUIDE

⚠ NB: *Remove any straps and eyelets from the camera as seen on page 8

1. REMOVE THE BACK FROM THE FRONT

Apply a slight upward pull to the locking knob and rotate anticlockwise until the pin is visible. Slightly lift the Back until it comes out from the guide pin on the knob. Remove the Back slantwise, paying attention to the two pins on the opposite side.

2. It is very important to lift the **SELECTOR AF/M** on the right of the housing before placing the camera inside.
3. Put the camera on the slide tray and screw it onto the tray until it is steady. Insert the camera attached to the slide into the interior of the housing. Run the slide on the guides from the front up to the stop.
4. Insert the hotshoe contact before closing the housing.

⚠ N.B.: Check that the hotshoe contact cable is inside the housing and is NOT caught between the Back and the Front.

6. CLOSE THE BACK.

Check that the O-rings seals are in place, intact, clean and properly lubricated.

Insert the two lower pins of the bottom in the specific slot.

Insert the pin in the guide of the closing knob; turn the knob until the closure is done and snap the safety by pressing it slightly down.

7. Reposition the **SELECTOR AF/M**.



PARTS OF THE HOUSING

FRONT

All camera controls are external and are laser-engraved with the symbols for the camera functions.

Please refer to the Identification of Parts Manual to see all controls of the housing.

All key **Nikon D7500 camera** controls can be accessed.

The front ends with the port/lens mount hole that allows to mount different ports.

Removable port -**B120mm bayonet**.

On top of the housing there are 2 fiber optic connectors and 2 electrical sync cord bulkheads. **One M16 hole** for installation of accessories, e.g. vacuum valves or monitors is also available.

Above, the single-hand closing knob for closing/opening the housing and detach the back completely. **M8 hole** located on upper side of the housing for various accessories such as focus lights, etc.

On both sides you can find ergonomic side handles, adjustable (via optional accessory). Wide, rubber covered feet on the bottom for solid footing.

Two M6 holes located on the bottom of the housing front side can be used for different accessories such as brackets for strobes or tripods.

INTERIOR

An easy and quick release camera mounting plate allows the camera positioning and a lever locks the tray inside the housing. The tray is made of plastic material and is provided with a not removable screw to fix it on the housing.

A lever lock on the tray secures the camera when inserted. Insert the camera through the two integrated guides of the plate support. Slide the lever to the right to lock the camera on the plate; to release it slide it to the left.

On the upper side the hotshoe should be to connected to the **hotshoe** of the camera. A special internal slot located on the right top of the housing interior allows you to lock the hotshoe when not in use.

Dual high-quality O-Ring seals on every movable part protect and ensure a perfect and secure watertight.



HANDLES

The handles of the DSLR housing are removable and adjustable in distance from the housing via optional handles extensions.

Depending on the need they extend the space between the handles and the housing's body to improve their use even with gloves on.

It is also possible to use the T-socket present on the handles to attach various accessories.

BACK

The back door features all key/main camera controls by means of clearly labelled laser-engraved longlasting buttons.

It has a large window anti-scratch polycarbonate for a fine camera display view and optical viewfinder view.

External viewfinders can be mounted ON REQUEST, INON X-2 compatible.

On the left of the back door there is a leaking **acoustic LED alarm**.

This component acts as an alarm in case of moisture inside the housing. An internal sensor will turn on the LED red: in the event that this happens consult the section

CORRECTION OF PROBLEMS.

Both LED and audible sensor are powered by an internal battery that is replaceable by the user. The alarm system is protected by a cover.

The back of the housing is entirely detached from the front body to make easier the camera fitting. To separate the Back from the housing is necessary to first disable the safety. This is done by applying a slight upward pull to the locking knob located on the upper part of the housing. You can then proceed with the removal of the back by turning counterclockwise the knob. Turn the back until the locking pin is visible.

At this point proceed pulling out slightly the back and extracting on the opposite side the two pins at the bottom from their seat.

The back door is equipped with two O-ring seals. We recommend to pay particular attention to them: they must be kept clean, intact and properly lubricated.



OPENING AND LOCKING THE HOUSING

Opening and closing the housing:

1. To open the housing place it on a flat surface, standing upright.
2. It is very important to lift the **selector AF/M** on the right of the housing before placing the camera inside.
3. The housing can be opened and closed by operating with only one hand. When opening, pull the opening knob, then turn the knob counter-clockwise until the back housing opens.
4. Remove the back of the housing by pulling it slightly upwards to release the two pins. In this way, it will be possible to separate completely the back housing from the front housing.
5. The camera is placed easily into the housing on a sliding tray that keeps the camera robustly in place. Switch the lever to lock the tray safely inside the housing.
6. To close, insert the two pins in their slots, insert the pins in the space on the opening knob, screw the knob until the end, and push it downwards to secure it safely. If you have not closed the back properly you may feel resistance when turning the knob. Open it again and check that camera is properly inserted, pins are in their slots, verify the shoulder strap clips have been removed and try again.
7. When closing, make sure there is nothing caught between the closing surfaces of the two halves of the housing and check that O-rings are clean.

⚠ IMPORTANT NOTE: *if you do not close the back housing correctly or there is something preventing the correct closure of the housing, the camera controls cannot work properly.*



INSTALLING THE CAMERA

⚠ NB: Remove any straps and eyelets from the camera before inserting it inside the housing as seen on page 8.

1. Turn the locking lever on the tray to the left to unblock it.
2. Remove the camera tray from the housing by sliding it outwards.
3. Attach the tray to the camera by tightening the screw to the tripod socket of the camera.
4. Install the camera by sliding the attached saddle along the rail in the housing until it cannot go in any further.
5. Lock the camera into place by turning the sliding lever to the “lock” position.
6. For removal of the camera from the housing, reverse the above procedures.
7. Close the housing as described in section “Opening and Closing the Housing”.

CHANGING THE VIEWFINDER

The viewfinder which comes with this housing is designed so that it can be removed and re-installed by following the simple steps described below.

INON X-2 viewfinders are compatible with this housing.

To remove the viewfinder:

- Remove the retainer ring of the viewfinder inside the rear half of the housing by making use of the recess on the ring. If you encounter resistance insert small Allen keys into the holes to gain more leverage;
- gently push the viewfinder from the inside of the housing.

To re-install the viewfinder:

- lightly coat the O-rings on the outer part of the viewfinder with lubricant;
- push the viewfinder from the outside of the housing until it cannot go in any further;
- place the retainer ring of the viewfinder back from inside the housing and fix the ring with Allen key or similar device.



MOUNTING THE PORT

Please refer to the **ISOTTA PORT CHART** for a range of compatible ports: the housing is supplied without ports that have to be purchased separately depending on the lens used.

⚠ IMPORTANT: ports needs to be mounted above water in dry conditions.

1. Inspect the O-rings for any damage and lightly coat them with **ISOTTA** lubricant before placing it back into its groove.
2. Verify that the porthole of the housing is clean and free from foreign material.
3. The port is inserted and removed through a bayonet mount. The port can be locked to the housing with a safety latch. Before inserting the port make sure lever is on **OPEN**.
4. Align the mounting indicators (white circles) on both the port and the housing.
5. Gently push the port into the opening of the housing, until it cannot go in any Further. Check all around the port to see if it is fully inserted
6. Screw port clockwise with both hands (to the right) by applying a light pressure on the housing until the port is in final position. Lock the port with port lock lever on the housing.
7. To remove the port unlock it by turning the lever to **OPEN** and unscrew the port counterclockwise (to the left) until the mounting indices of the port and the housing are aligned and gently extract the port.

It is recommended to replace the port above water in dry environment after the all water droplets on the surface of the housing have been removed.

It is possible to mount ports of different brands - adapter rings can be ordered from Isotta. When using the adaptor rings the safety lock feature is not working.

⚠ NOTE. The first few times there may be resistance when turning the port. Make sure O-rings are well lubricated. Double O-rings might generate resistance when new. If you cannot turn the port, check that both O-rings are inserted and in place and that the port is attached entirely to the housing. If so, hold firmly the housing, while you turn the port with both hands to turn the port.

- *The ports must be replaced above water and in dry environment. Housing should be dry and user should have dry hair (to avoid drops entering the housing).*
- *Do not leave ports mounted for long periods of time.*
- *If port is stuck due to flight or long inactivity the best way to release the port is by:*
 - a) having another person hold the housing with two hands;*
 - b) if an extension ring is stuck it is easiest to mount a dome port and use it to twist the extension ring counter-clock wise.*
- *Best performance and seal is achieved by using Isotta ports.*
- *Do not use solvents on the port. To clean them you should use microfiber cloth or Q-Tips. If necessary, you can use mild soap only on the outside.*



IMPORTANT: when using **Aquatica or Hugyfot ports** with Isotta extension rings please pay attention when using a fisheye lens (with a field of view of 180°) as there might be a slight vignetting. With **Sea & Sea, Subal and Seacam ports** with Isotta extension rings this does not happen as the extension to the port is at the same distance.



CAUTION



DOMES PORT	MAXIMUM DEPTH
Spherical Dome Port 4,5" Crystal -B120	100 metres
Spherical Dome Port 6" Polycarbonate -B120	100 metres
Spherical Dome Port 6,5" Crystal -B120	70 metres
Spherical Dome Port 9" Crystal -B120	60 metres

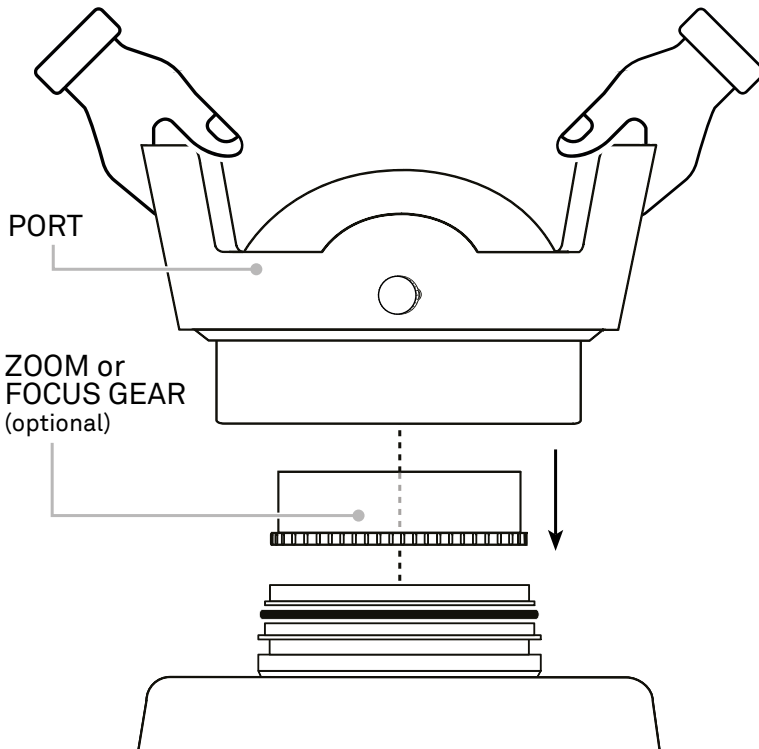



USING THE FLASH

You can use the external flashes with the following modalities:

With OPTICAL FIBER

Two fiber optic connectors are present on the housing top with standard “Sea & Sea” fitting. In this case you have to use the bushings for optical fiber placed on the top. Pass the optical fiber cable of the flash in the specific space on the bushing. With Optical Fiber you have to use pull up flash of the camera.

HOW TO CHANGE BATTERY

To remove the battery, use a small flathead screwdriver to lift up the battery. Install a **CR2450 battery** into the battery compartment inside the front housing.

With SYNCRO CORDS

Strobes from **SEA&SEA, INON, IKELITE** and **Subtronic** must be used in **Manual power modes** when connected via electrical sync cord.

An internal electric circuit controls the two syncro cords by means of 3 switches. If the switch is positioned on **[ON]** it will be possible to **work with the flash in manual or TTL** mode as indicated *in the figure below*:

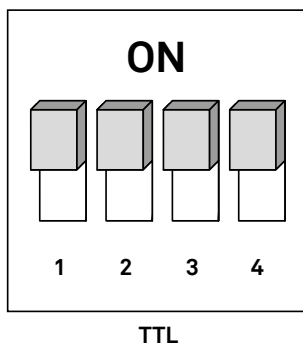
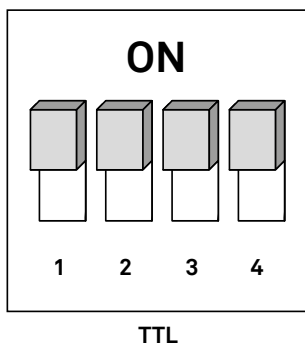

! N.B. this is also necessary in case of any troubles when using syncro cords with the strobe in manual mode.



If you have problems with strobes from **SEA&SEA, INON, IKELITE** and **Subtronic flash** you **switch the 1 / 2 / 3 pins on [OFF]** as indicated in the figure below.

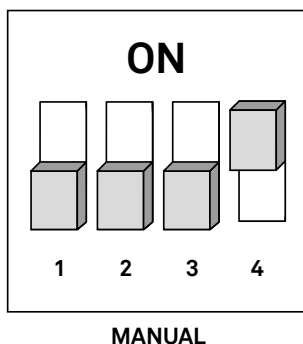
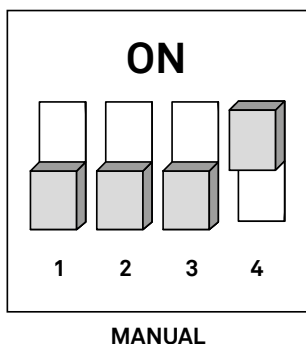

To insert SYNCRO CORDS

- To attach a strobe via electrical sync cord you have to use the bushings with syncro socket placed on the side of housing.

⚠ N.B. A bulkhead cap or sync cord must be attached to the housing for waterproof operation. Never submerge the housing without either a sync cord or waterproof bulkhead cap attached.

-Remove the bulkhead cap by unscrewing the plug inserted into the socket anticlockwise (to the left) with the help, if necessary, of a screwdriver or a coin.

-Line up the pins and receptacles and insert the sync cord plug into the housing bulkhead. Attach the other end of the sync cord to the bulkhead on your strobe. Then tighten the ferrule that acts as a safety.

Once the use of the flash is completed we recommended to remove the cable connector of the flash from the attach and proceed with the closing of the plug. Before buying a flash make sure it can be matched with the camera housing.

⚠ ATTENTION: to attach a strobe via electrical sync cord you have to use the bushings with syncro socket placed on the side of housing. *A bulkhead cap or sync cord must be attached to the housing for waterproof operation. Never submerge the housing without either a sync cord or waterproof bulkhead cap attached.*



TROUBLESHOOTING

- **BUTTONS DO NOT WORK**

Check the correct positioning of the camera;

- **BUTTONS GET STUCK**

Apply lubricant to the button. Press the button several times to distribute the lubricant.

⚠ N.B.* Don't use vaseline grease on the O-ring seals.

We recommend the use of original **ISOTTA** products.

- **THE FLASH DO NOT SHOOT IN SYNCRO MODE**

Make sure you have inserted the hotshoe contact all the way down and check that you entered correctly the flash contact.

- **TRACES OF SALT ON JOINTS WHILE ASSEMBLY HOUSING**

Salty water on the joints: rinse well and wipe the points with Vaseline oil, except for the optics, which should be cleaned only with special detergents.

- **RED LED IS ON**

A red LED and acoustic signal on the back of the housing indicates excessive moisture inside the housing. If this happens underwater, you should get out of water as soon as possible in respect of security measures and ensure that there were no leaks.

Re-clean and re-install the back and port O-rings. Take the housing underwater without a camera installed to ensure that the leaking has been corrected.



WARNINGS

- **CHECK** the housing before installing the camera after dispatch or transport it by plane.
- **DON'T TRANSPORT** the housing hermetically sealed on a plane. Always remove the port or the rear cap or the rear cap's o-rings. If you remove the O-rings, then remember to put them back on.
- **MAKE SURE** above all of the integrity of the seal between the back door and O-rings.
- **LUBRICATE** with a minimal amount of silicone grease the two O-rings located on the rear cap.
- **DON'T CARRY** the housing with the camera placed inside to avoid stress to the camera itself.
- **NEVER EXPOSE** the case in direct sunlight, as the color might fade and in order to prevent damage to the internal circuitry.
- **CHECK** that the port is always clean (never degrease it with solvents, acetone, paint thinner, etc. to avoid serious damage to the optical treatment). Only clean it with liquid, cloths or optical cloths.
- **AVOID** sharp blows on the command buttons, front lens and ports.
- **AT THE END** of each dive rinse the housing in fresh water.

 **CAUTION:** rinse and dry the lens, in order to avoid chalky deposit formations that over time would ruin irremediably the optics and the housing.

 **N.B.*: KEEP THE HOUSING TIGHTLY CLOSED when you rinse it.**

Before removing the camera from the housing make sure the housing is dry to avoid that any drop of water causes damage to the camera.



CARE AND MAINTENANCE

- It's a good practice to rinse the housing with fresh water, ensuring it is properly closed, after each salt water use. Then dry it accurately. Run water in the greatest stagnation points of salt water as perimeter rings, caps, lens, eyepiece, command buttons and levers.

⚠ WARNING: it is advisable to operate the control buttons during the rinse, so as to remove any residual salt within that, in the long run, it could lead to blockage.

- Before removing the rear cap, make sure that the housing is completely dry.
- We recommend to remove the port after every use to avoid its blockage.
- It's a good practice to clean and grease the O-ring with silicone grease without exaggerating. It is recommended to use special silicone grease for O-rings. If using unsuitable grease or spray, you may experience O-ring swelling or their expansion, affecting the seal. You need to grease the O-ring away from towels, bathrobes, tablecloths etc. or places of stagnant dust, because the grease protects the O-ring, but attracts various lightweight materials such as fur, hair, fibres, grains of salt, sand, etc. These particles are difficult to see because of the presence of grease. You must therefore pay particular attention to the cleanliness of the O-ring, otherwise you could create flooding, that would certainly have been avoided with a correct maintenance. Replace the main O-ring annually.
- When you do not in use the housing for a long time you must to remove the O-rings and sprinkle all the external metal parts with a light coat of vaseline oil.

⚠ N.B.*: never use Vaseline oil to lubricate the O-rings, use only silicone grease. We recommend the use of Isotta products.

- Do not use solvents, thinners, or alcohol to clean the port, the eye-piece or the monitor.
- Treat the surface of the lens port like a camera lens. After use, rinse and gently dry the outside lens port to avoid water spotting. To clean, use a mild soap solution or lens cleaner. Do not rinse the inside of the Port. Never use alcohol or window cleaner on the Lens Port.

It is recommended that you ship the housing to our distributor or to Isotecnic factory for a complete overhaul every 2 years or after 500 dives.



NOTES

No reproduction in any form of this manual, in whole or in part, may be made without written authorization from ISOTECNIC Srl.

26/06/2020 - ISOTECNIC Srl reserves its right to modify the actual product due to product or service enhancement or technical updates without prior notice.

All trademarks mentioned belong to their owners, third party brands, product names, trade names, corporate names and company names mentioned may be trademarks of their respective owners or registered trademarks of other companies and are used for purposes of explanation and to the owner's benefit, without implying a violation of copyright law.



Via Milano, 177/B | Castelnuovo del Garda (VR) | 37014 | Verona | Italy
Tel. +39 045.6450480

info@isotecnic.it | www.isotecnic.it

Follow us on   